



# BÂTIMENT ÉCRAN NORD

## 2<sup>ÈME</sup> ÉTAGE

-  Surfaces de bureaux  
1'242.90 m<sup>2</sup>
-  Surfaces de circulations  
17.80 m<sup>2</sup>
-  Locaux techniques

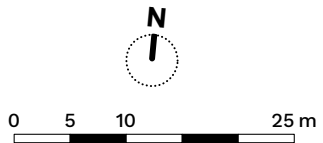
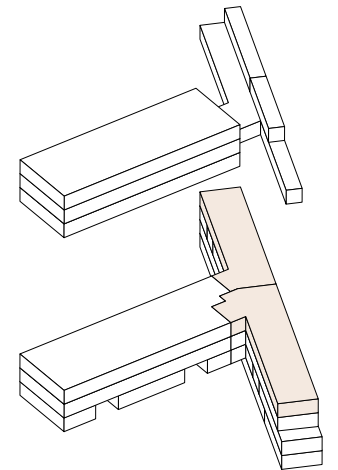
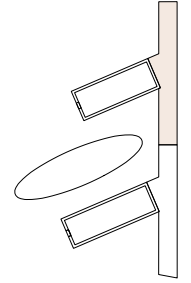
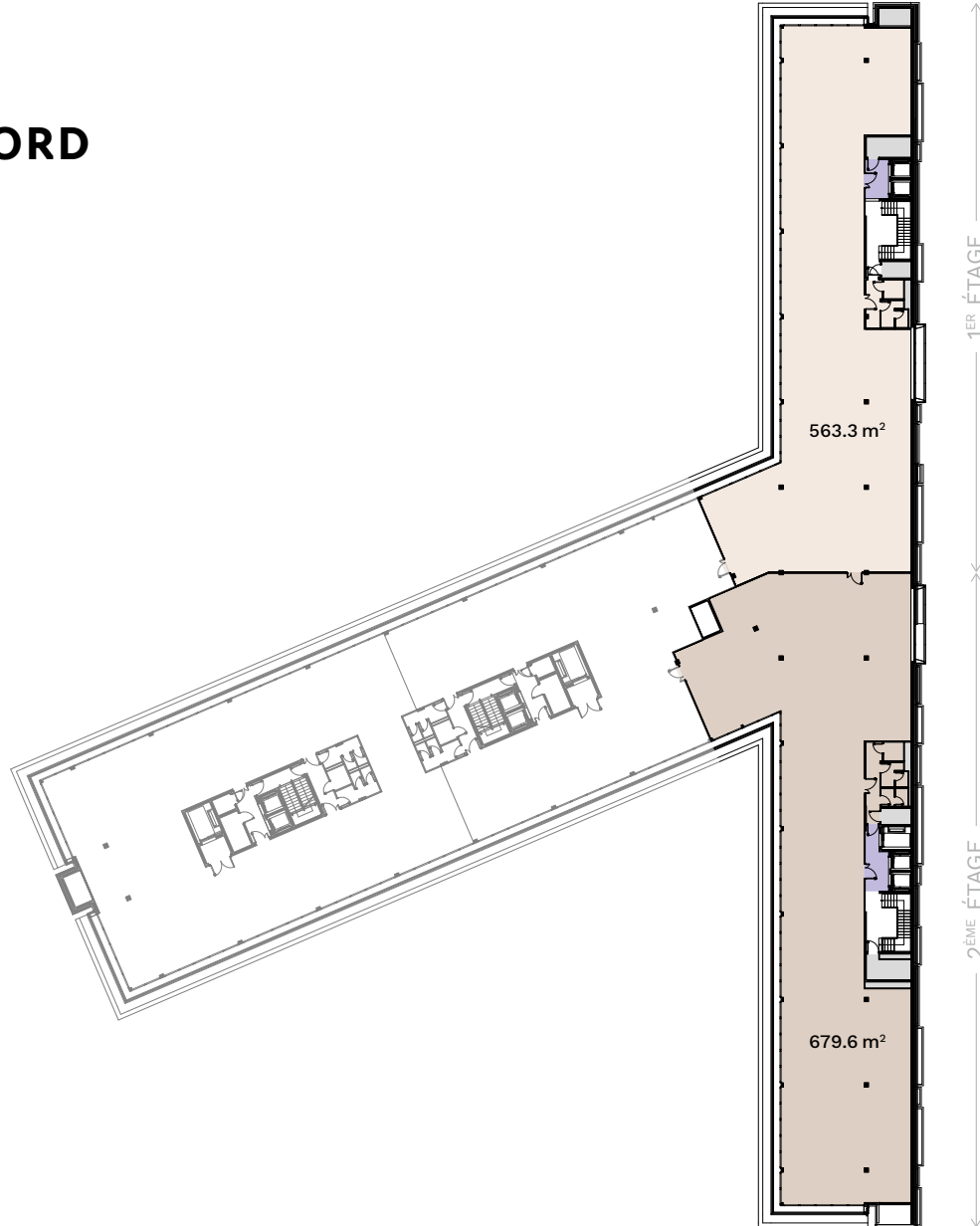

Les surfaces utiles effectives peuvent varier par rapport aux indications des plans. Sous réserve de modifications.