



BÂTIMENT ÉCRAN SUD

2^{ÈME} ÉTAGE

-  **Surfaces de bureaux**
521.70 m²
-  **Surfaces de circulations**
10.40 m²
-  **Locaux techniques**

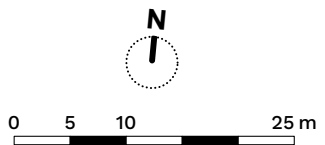
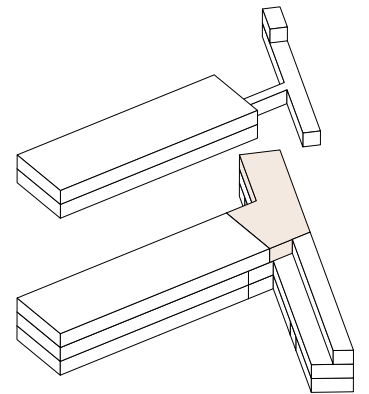
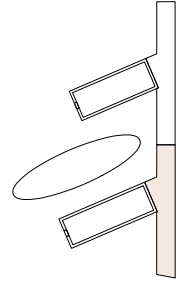
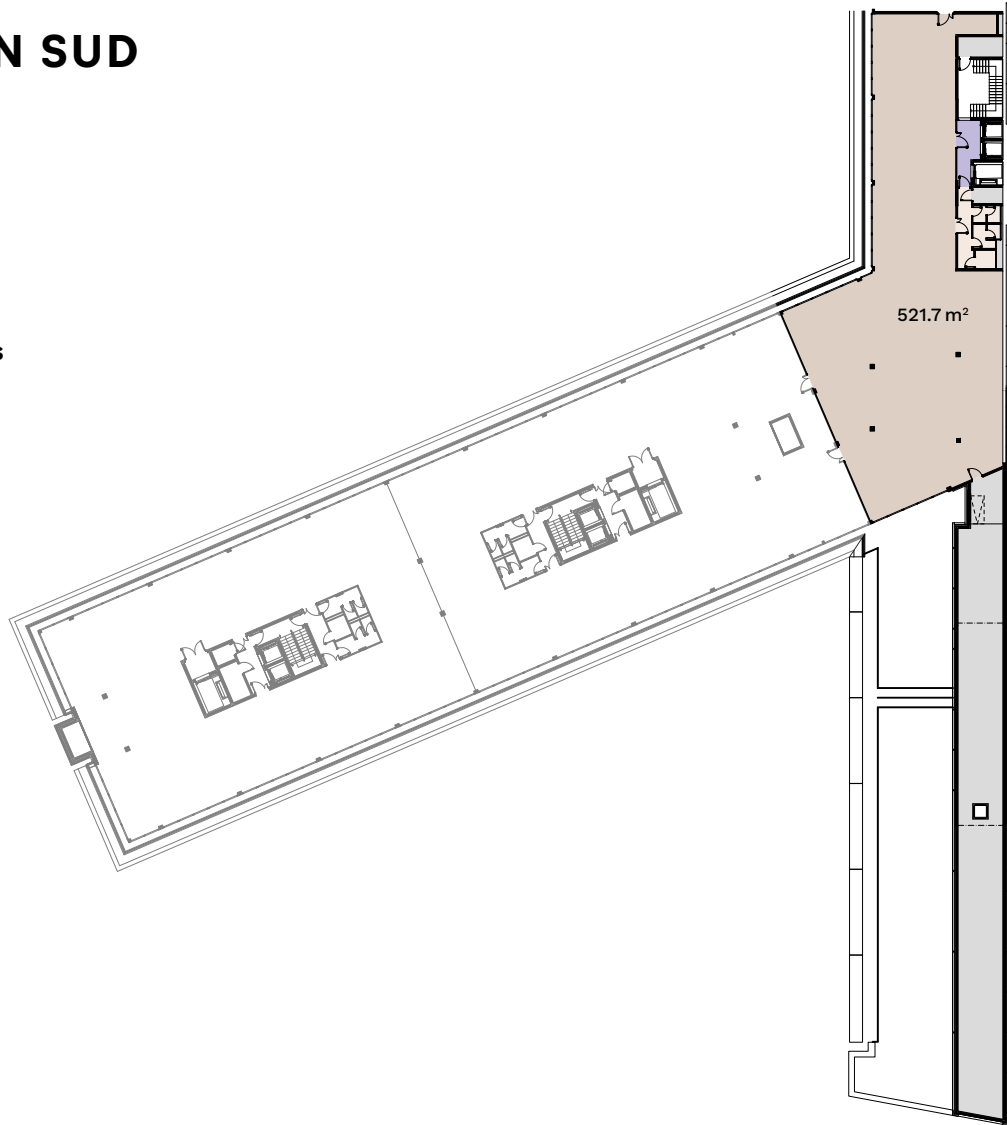

Les surfaces utiles effectives peuvent varier par rapport aux indications des plans. Sous réserve de modifications.